

MSUD VALVE PLUG FORM A 18MM

PVC 3X0.75 GRAY, 20m

MSUD

Form A (18 mm)

0...230 V AC/DC

without components

Further cable lengths on request.

Plastic housings with good resistance against chemicals and oils.

The resistance to aggressive media should be individually tested for your application. Further details on request.

Illustration

stay connected

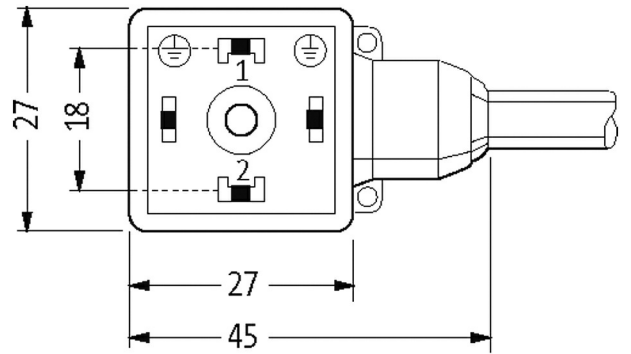

Height: 30 mm

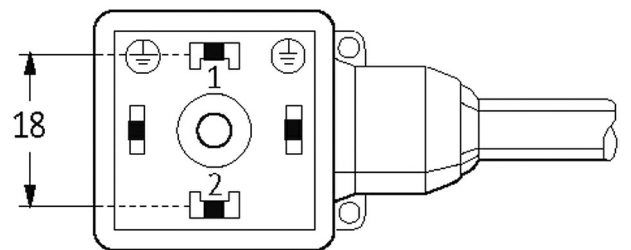
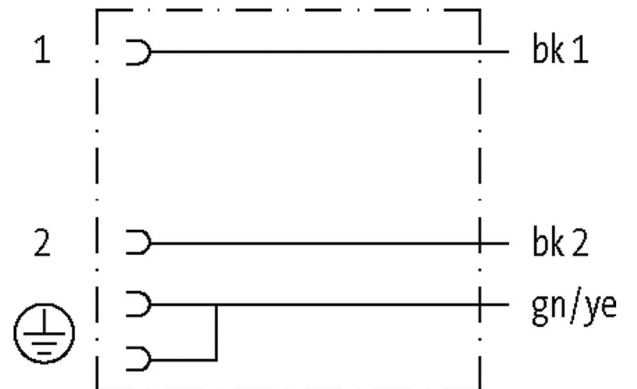

Product may differ from Image

Approvals

cCSAus

* only for products with UL/CSA approved cable

Form

Form

18081

Cables

No./diameter of wires	3 × 0.75 mm ²
Wire isolation	PVC (bk num, gnye)
Material (jacket)	PVC
Outer Ø	5.9 mm ±5%
Bend radius (moving)	10 × outer Ø
Temperature range (fixed)	-30...+70 °C
Temperature range (mobile)	-5...+70 °C
Cable identification	216
Cable Type	1 (PVC)
Approval (cable)	CE conform
Cable weight [g/m]	63,80
Material (wire)	Cu wire, bare
Resistor (core)	max. 26 Ω/km (20 °C)
Single wire Ø (core)	0.2 mm
Construction (core)	24 × 0.2 mm (multi-strand wire class 5)
Diameter (core)	3 × 0.75 mm ²
AWG	similar to AWG 18
Material (wire isolation)	PVC
Material property (wire isolation)	CFC-, cadmium-, silicone- and lead-free
Shore hardness (wire isolation)	43 ±5 D
Wire-Ø incl. isolation	1.8 mm ±5%
Color/numbering of wires	bk numbered, gnye longitudinally striped
Stranding combination	3 wires twisted
Shield	no
Material (jacket)	PVC
Material property (jacket)	CFC-, cadmium-, silicone- and lead-free
Shore hardness (jacket)	80 ±5 A
Outer-Ø (jacket)	5.9 mm ±5%
Color (jacket)	gray
chemical resistance	good resistance to oil, gasoline and chemicals
Nominal voltage	300/500 V AC
Test voltage	3000 V AC
Current load capacity	to DIN VDE 0298-4
Temperature range (fixed)	-30...+70 °C
Temperature range (mobile)	-5...+70 °C
Bend radius (fixed)	5 × outer Ø
Bend radius (moving)	10 × outer Ø
Jacket Color	gray

Technical Data

Operating voltage	max. 230 V AC/DC
Operating current per contact	max. 10 A
Rated surge voltage	4.0 kV
Material group	IEC 60664-1, category I
Locking of ports	M3 (recommended torque 0.4 Nm)
Protection	IP67 inserted and tightened (EN 60529)
Material	PBT
Housing	Black plastic (gray on request)

General data

Pollution Degree	3
Temperature range	-25...+85 °C, depending on cable quality

Commercial data

country of origin	CZ
customs tariff number	85444290
EAN	4048879191920
eClass	27279218
Packaging unit	1